

DK20 DK16



Digital Knight DK20 - 16x20 and DK16 - 14x16 Digital Clamshell

Version II-17



Contents

| | |
|--|----|
| Introduction | 3 |
| Setup & Suggestions | 4 |
| Normal Operation | 5 |
| Normal Operating Mode | 5 |
| Setting Temperature | 5 |
| Setting Time | 6 |
| Pre-Press Timer | 6 |
| Setting Pressure | 7 |
| Digital Pressure Bar Graph | 8 |
| Auto-Release Upgrade | 8 |
| Guidelines & Standard Settings | 9 |
| ERR Mode | 10 |
| Over-Temp Alarm | 10 |
| Programmable Presets | 11 |
| How Presets Work | 11 |
| Loading a Preset | 11 |
| Editing/Programming a Preset | 12 |
| A Walkthrough Tutorial for using Presets | 13 |
| User Menus | 14 |
| Entering the user menus & options | 14 |
| Fahrenheit / Celsius | 14 |
| Timer Counter Units | 14 |
| Recorded Pressings Odometer | 15 |
| Pressings Countdown Odometer | 15 |
| Pressure Minimum | 16 |
| Pressure Maximum | 16 |
| Temperature Drop Sense | 17 |
| Temperature Drop Sense Timer Disable | 18 |
| Keypad Beeper | 18 |
| Alarms | 19 |
| Finished Warning Beep | 20 |
| Prepress Timer | 20 |
| Prepress Alarms | 21 |
| Operator Lockout | 21 |
| Parts / Maintenance / Misc | 22 |
| Interchangeable Tables | 22 |
| Maintenance | 22 |
| Replacement Parts | 23 |
| Wiring Diagram | 24 |
| Troubleshooting | 25 |
| Troubleshooting (cont.) | 26 |
| Limited Warranty | 27 |

Introduction

Congratulations on your purchase of the DK20 16x20 or DK16 14x16 clamshell press! This heat press machine has many exciting features, all of which are meant to help make your heat transfer pressing endeavors as successful and easy as possible. Please take the time now to thoroughly read through this manual to become acquainted with them. It will explain some key features, concepts and methods that will save much time and effort in using this press and in your heat pressing applications.

Throughout this manual, many areas and components of this machine will be referred to by specific names. Please refer to the illustrations below in order to become familiar with some of the terminology used in this manual.

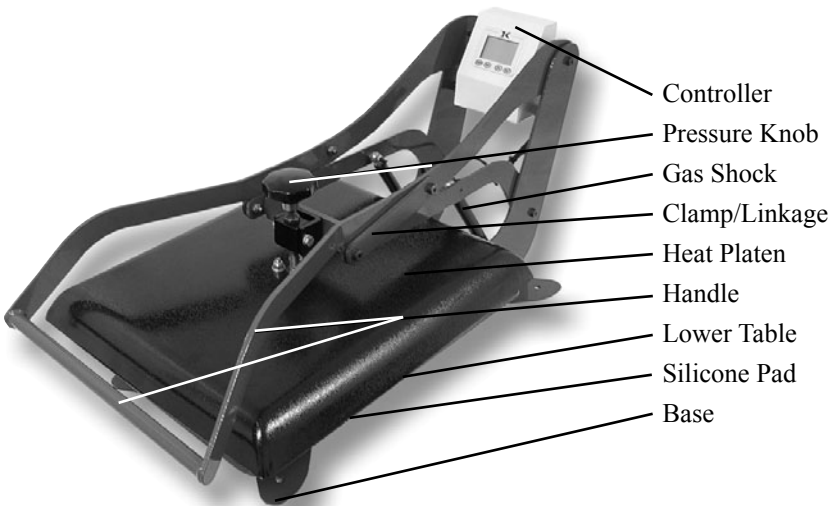

Default Operating Mode of Controller

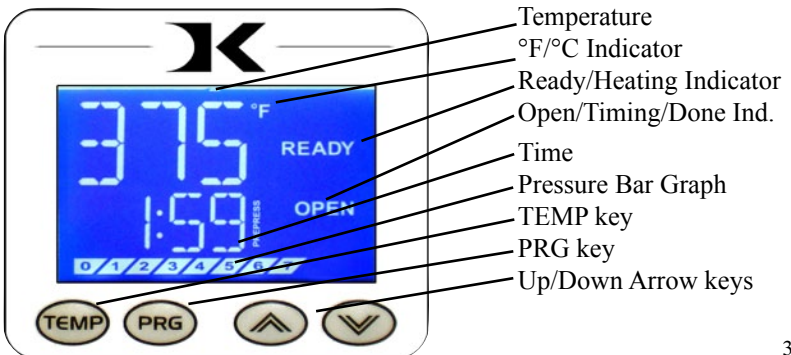

Setup & Suggestions

- Locate the press on a firm, sturdy work surface. It is recommended to bolt the press to a workbench using the rear and front mounting holes on the base frame. The clamshell presses can “hop” when opened abruptly, especially with the auto-release upgrade. This can cause undesirable movement of the work on the bottom table. Bolting the frame of the press to the workbench greatly reduces this.
- A stand on lockable casters is available from Geo Knight & Co or your distributor.
- The height of the bench/work space the press is located on would be ideally 27” to 32” high. The higher the press, the more difficult to close/lock.
- Attach the power cord from the rear to the backside of the controller. There is a power inlet on the back panel of the control box for the power cord.
- Make sure the power cord can not be pulled on. Make sure there is no tension on the inlet socket that the power cord plugs into
- The press should remain in the unclamped OPEN position when not in use. Do not leave the heater block closed on the table when not using, unless transporting.
- Do not leave the platen down on the silicone pad when heating. Always leave the heat platen in the UP position.

Normal Operation

Normal Operating Mode

The normal operating mode of the press will display the current actual Temperature at the top of the screen and the time setting or elapsed time below the temperature.

The right side the screen will indicate the heating status by stating HEATING, READY, both of those words, or none at all,

depending on if it is cooling down or heating up to the set temperature. READY is shown only if the current temperature is within 5 degrees of the set point temperature.

The right side of the screen will also indicate the timing status by stating OPEN, TIMING or DONE. The DONE indicator may remain on in some cases until the press is opened back up.

If the pressure feature is enabled, the pressure bar graph will show the last known pressure exerted when the press was closed.



Setting Temperature

From the normal operating mode, simply press the TEMP key to set the temperature.

The flashing 3-digit number is the temperature setting (not the actual current temp). Use the Arrow Keys to set the desired temperature. Hold them down to increase rapidly, press both together to set it to 350°F.

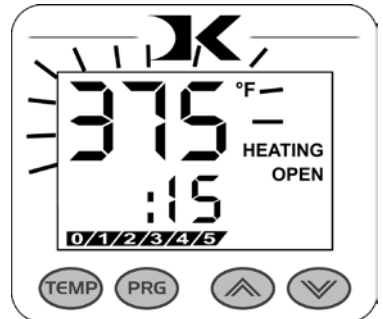

Press TEMP again to lock in the setting.

Setting Time

From the normal operating mode, simply use the Arrow Keys ONLY to set the time. Do not touch the PRG key.

Hold down either the Up or Down arrow key for more than 2 seconds and the time will increase rapidly.

Press BOTH Arrow Keys and the time will reset to 00 seconds.



Pre-Press Timer

There is a second timer available for use, called the “Pre-Press Timer”. This feature is useful if a multiple-step process is performed.

For example: If a product must be pre-pressed for 5 seconds before a main pressing cycle of 20 seconds, the Prepress timer can be set for 5 secs, and the main timer for 20. When the operator closes the press, the 5-sec time counts down. When the operator opens the press, the time setting switches to 20 seconds.



The word PREPRESS will be displayed next to the pre-press time setting when it is active. To set the pre-press time, simply use the Arrow Keys to set the time. If PREPRESS is not displayed next to the time, quickly close and then open the press to switch to the prepress time.

To turn ON the prepress timer feature, enter the User Options Menus (see page 14) and go to the PPR setting and turn it ON. (see page 18)

Setting Pressure

Pressure is set manually using the large black Pressure Adjustment Knob. There is one important rule of thumb when setting pressure: The press **MUST LOCK IN PLACE** when lowering and clamping the press. Do not simply let the platen rest on the pad. A good solid two-handed locking force is recommended when first doing transfers to insure good results. A “Ka-Thunk” click/clamp sound will result when locking the press in place.

- To decrease the pressure, turn the pressure knob to the right, clockwise. The top head will rise away from the lower table.
- To increase the pressure, turn the pressure knob to the left, counter-clockwise. The top head will lower toward the pressing table.

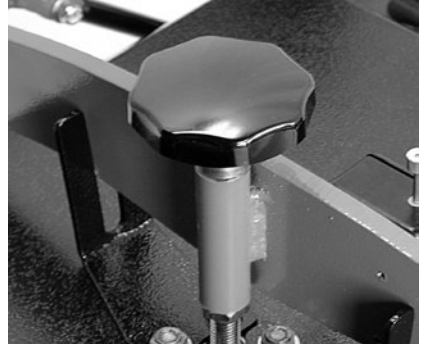

WARNING: The heat platen will become detached from the frame and drop onto the table if it is adjusted too far.

Please use caution when attempting to increase pressure by turning the knob to the left (unscrewing: counter-clockwise).

Digital Pressure Bar Graph

The Digital Pressure Bar Graph indicates a basic 0-9 scale of pressure exerted. The pressure bar graph resets when the press is closed/locked while timing.



If the pressure adjustment has been changed, or a different thickness item has been placed in the press, the pressure bar graph will not change until the press is closed and locked and the timer is counting.

This bar graph is directly related to the amount of pressure, or resistance, being felt and applied to the bottom table. If a thicker item is placed in the press, and no adjustments are made to the pressure knob, then the amount of pressure clamping down will be greater, and the bar graph will show a higher number. Here are some bar graph guidelines:

A very light pressure slight clamping would be in the 0 to 3 range.
A good medium pressure for most applications would be 4 to 6.
Excessively high pressure for demanding items would be 7 to 9.

Auto-Release Upgrade

The DK20 and DK16 are upgradable to an automatic release feature. This allows for the automatic opening of the handle without operator involvement.

When operating a DK20 or DK16 with auto-release, be sure the FWB (Finished Warning Beeper - see page 19) is set to on. This will warn the operator audibly 3 seconds prior to opening.

NOTE: The magnetic device will not activate if the timer is not counting down. If the timer will not count, see page 23 for troubleshooting the timer.

The magnetic locking mechanism may come with a 2-position Hover Bracket. This upper bracket allows the operator to lower the press in a “resting” position, not fully locking/clamping in place, to simply heat-cure the lower surface. The operator can also fully lock/clamp the press with firm pressure as well without any adjustments.

Guidelines & Standard Settings

The following information covers some basic guidelines for pressing, as well as some generic parameters for basic heat transfer applications.

- When pressing shirts, it is often recommended that the shirts be quickly pressed for 2 to 4 seconds before transferring to remove wrinkles and water content.
- When pressing two sides of a garment, pull the garment over the table so that the printed side drapes underneath the table. This will avoid reheating previously transferred designs on opposite sides of garments. It will also avoid any bleed-through of inks on lighter fabrics.
- Avoid laying collars, cuffs, zippers, and other bulky parts of garments on the lower table, as these can adversely affect pressing conditions, and reduce the life of the silicone pad.
- When pressing rigid substrates (plastics, metals, woods, etc.), be sure that any protective films or laminates are removed before heating.
- Always check that the transfer image is face down against the material, to avoid sealing the image against the heat platen instead of the substrate.

Always follow the transfer media suppliers instructions when pressing. The information below is for general reference only, and may not be as accurate as the instructions provided by the transfer media & imprintable substrate supplier.

- | | |
|--|---|
| • Hot Split Supplier Transfers | 350-375°F, 8-10 secs |
| • Puff Transfers | 350-375°, 5-7 secs (extra heavy pressure) |
| • Ink-Jet Transfer Papers | 360°, 15-18 secs |
| • ColorCopy/Laser Transfer Papers | 375°, 20-25 secs |
| • Sublimation Inks (Polyester Fabrics) | 400°, 35 secs |
| • Sublimation Inks (Plastics) | 400°, 1 min, 15 secs |
| • Sublimation Inks (Metals) | 400°, 1 min |
| • Sublimation Inks (Woods) | 400°, 1 min, 15 secs |
| • Sublimation Inks (Ceramics) | 400°, 4 min |

ERR Mode

During operation of the press, if there is a loss of signal from the temperature sensor wire, the ERR display will appear.

This is a safety feature that will shut off the relay so the press will not overheat aimlessly without a temperature signal.

Once the temperature signal is restored (no longer broken, or plugged back into the control) the press will resume the temperature display, and start heating if necessary. If ERR persists, contact support.



Over-Temp Alarm

If the press heats beyond the set temperature by 40 degrees or greater, the OverTemp alarm will sound.

This is a safety feature that warns the operator of a possible thermal run-away of the press. This means the press relay may be locked in a heating position where it will never stop heating, to a possibly harmful temperature level.

If the OverTemp alarm sounds, set the temperature to a higher value than the current actual temp. Wait 30 seconds and then reset the press to your desired temperature and Watch Carefully. Do not let the press rise to extremely high temps.

If it continues to rise, turn off the press and let it cool off to room temperature. Turn the power back on and immediately set the temperature to a low setting like 200°F. Wait for the press to heat up. When the press displays "READY", monitor the temperature and see if it continues to heat to a level that the OverTemp alarm activates again. If so, contact the factory.



Programmable Presets

How Presets Work

There are 70 programmable presets in the controller. The operator can store a Temperature, Time, Prepress Time, and Pressure setting in each preset.

When a preset program is loaded by the operator, the Current Temperature Setting, Time and Prepress Settings (if there is a Prepress setting in that preset) are updated in the normal operating mode.

The pressure is NOT set for the operator mechanically. A brief display of the pressure value in the preset is shown while updating the current settings. This is simply a reference... a reminder of what pressure setting the operator must adjust for that preset.

There are 2 main functions to using the presets. **LOADING** and **EDITING** the preset. **LOADING** a preset simply means selecting a desired preset, and returning to the normal operating mode where the current settings are changed. **EDITING** a preset is when the operator actually changes the preset's settings.

Loading a Preset

To enter the presets, press the PRG key.

SET will display on the screen.

Use the Arrow Keys to select a preset from 00 to 70.

Press PRG to return to the normal operating mode. The current active Temperature, Time & Prepress time settings (if there is a prepress setting in that preset) are now updated with the presets values.

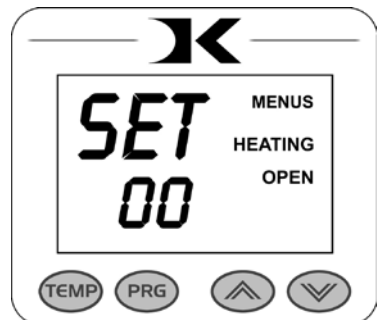

Editing/Programming a Preset

To edit a preset and change its values to your own desired settings, you simply use the TEMP key while in the SET preset mode.

From the normal operating mode, press the PRG key. SET displays on the screen. Use the Arrow Keys to select the preset # you wish to edit.

Press the TEMP key. The temperature will flash. Use the Arrow Keys to set the temperature for that preset.

Press the TEMP key. The time will flash. Use the Arrow Keys to set the time for that preset.

Press the TEMP key. The Prepress time will flash. Use the Arrow Keys to set the Prepress time. Set the Prepress time to 00 if only one timer is to be used for that preset. Setting Prepress to 00 will disable the Prepress feature.

Press the TEMP key. The Pressure reference value will flash. Use the Arrow Keys to set the pressure for that preset. This will display 0 to 9 for presses configured for Bar Graph Pressure readout, and will display 0:00 to 10:00 for presses configured for a Height Gauge readout.

Press the TEMP key. The screen returns to the preset #. Press PRG to return to the normal operating mode, or use the Arrow Keys to select a different preset and edit that as well.

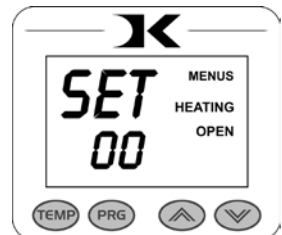
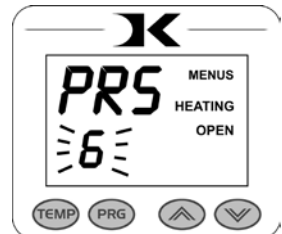

A Walkthrough Tutorial for using Presets

Here is a tutorial of programming 2 different presets, and then an example of using them in normal daily operations. Do this walkthrough to practice using presets.

Part 1: Programming 2 different presets.

From the normal operating mode, press PRG. SET appears.

Use the arrow keys to select SET 01.

Press TEMP. Set the flashing temperature to 400 with the arrow keys.

Press TEMP. Set the flashing time to 45 with the arrow keys.

Press TEMP. Set the flashing Prepress time to 00 with the arrow keys.

Press TEMP. Set the flashing Pressure ref to 6 with the arrow keys.

Press TEMP. Use the arrow keys to select SET 02.

Press TEMP. Set the flashing temperature to 350 with the arrow keys.

Press TEMP. Set the flashing time to 12 with the arrow keys.

Press TEMP. Set the flashing Prepress time to 3 with the arrow keys.

Press TEMP. Set the flashing Pressure ref to 8 with the arrow keys.

Press TEMP. Press PRG to leave the preset mode.

Presets SET 01 and SET 02 have now been programmed.

Part 2: Loading the presets. Let's say we are powering on the machine and starting a job. The first job will need to use preset 01, and later on the next job will need preset 02.

From the normal operating mode, press PRG. SET appears.

Use the arrow keys to select SET 01 then Press PRG. Done!

The press is now set for 400°F and 45 seconds and will start to heat to that temperature. When leaving the presets, the screen briefly displayed PRS 6 - indicating you must manually set the clamping pressure so the bar graph shows 6 (or close to it) at the bottom of the screen.

Now let's change to the next job. Press PRG. SET appears.

Use the arrow keys to select SET 02 then Press PRG. Done!

The press is now set for 350°F, 12 secs, 3 prepress, and you are reminded to set the pressure heavier to 8 on the bar graph display (when closed).

That's it! You can load a preset as often as needed: just press PRG, pick the preset you want with the Arrow Keys, and press PRG again.

User Menus

Entering the user menus & options

There are many useful features beyond simply setting time & temperature, and storing presets. All of these additional features are available to the operator in the User Menu.

To access the user menus, simply press TEMP & PRG at the same time from the normal operating mode and let go.

(Try to use two hands and press the keys at the exact same time. If one key is pressed too early from the other, the temperature setting or preset modes may be activated instead. Turn the press off and then on and try again.)

Fahrenheit / Celsius

The current and set temperature can be displayed in °F or °C. After entering the user menu (see above), use the arrow keys to select F or C. Press PRG to move to the next menu item.

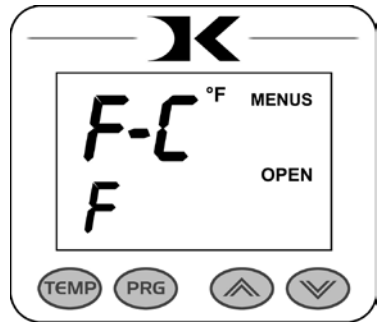

Timer Counter Units

The timer and Prepress timer can be set for mins/secs (default) or hours/mins. If special applications need a higher timer range than 99 mins, 59 secs, this can be changed. After entering the user menu (see top of page), Press PRG until CNT displays. Use the arrow keys to select SEC or HR. Press PRG to move to the next menu item.

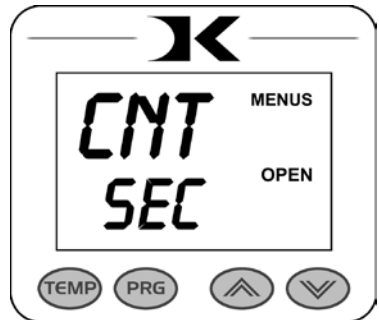

Recorded Pressings Odometer

There is an “odometer” that records pressing cycles done. This can be cleared and reset to 0 at any time when needed. The figure scrolls and it’s beginning and end are separated by a “-” sign.

After entering the user menus (see top of page 9), Press PRG until REC displays. Use the arrow keys to reset the counter to 0. Press PRG to move to the next menu item.



Pressings Countdown Odometer

There is a second type of “odometer” that counts down the number of pressing cycles from a set amount.

After entering the user menus (see top of page 9), Press PRG until CTD displays. Use the arrow keys to set it ON or OFF.

When this feature is ON - the normal countdown timer display is replaced by this odometer instead. The arrow keys no longer adjust the countdown timer, but instead are used to set the countdown odometer. When OFF, the timers are visible.



The timer & prepress timer (if ON) still operate. However they are not visible. Instead, at the end of every main timing cycle (but not prepress), the odometer decreases by 1. This way, the operator can keep track of how many pressings are left to do, without checking the REC menu.

This feature is useful when a specific amount of pressings must be performed, and the operator must be aware of how many pressings are remaining. Simply use the arrow keys to adjust this value in the normal operating mode (just like they are normally used to change the time). This value will automatically decrease at the end of each timing cycle.

Press PRG to move to the next menu item.

Pressure Minimum

To reset and redefine “0” for the pressure bar graph, use this calibration menu. **Do NOT adjust this setting unless you are sure adjustments are necessary.**

Adjust the pressure of the machine so there is barely any locking pressure when clamping and locking the press. Press either Arrow Key. The press now considers this pressure as “0” on the Pressure Bar Graph Display.

Press PRG to move to the next menu item.



Pressure Maximum

To reset and redefine “9” for the pressure bar graph, use this calibration menu. **Do NOT adjust this setting unless you are sure adjustments are necessary.**

Adjust the pressure of the machine so there is extremely heavy pressure when clamping and locking the press. Press either Arrow Key. The press now considers this pressure as “9” on the Pressure Bar Graph Display.

Press PRG to move to the next menu item.

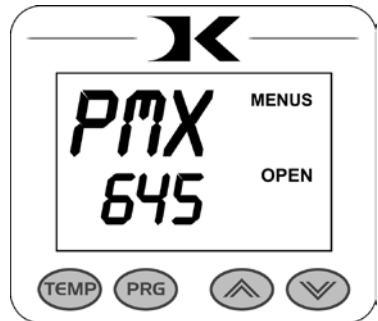

Temperature Drop Sense

The press can be set to alarm if the temperature drops a certain range below the set temperature. This is useful to warn the operator if the press is too far out of temperature range during excessive use.

After entering the user menus (see top of page 13), Press PRG until DRP displays. Use the arrow keys to set it to OFF (default), or 10, 20, 30, etc.



If the current temperature drops below the set temperature by that many degrees, and alarm will sound. Press TEMP to silence the alarm.

Press PRG to move to the next menu item.

Temperature Drop Sense Timer Disable

The press can be set to disable the timer if the temperature drops a certain range below the set temperature. This is useful especially on automatic presses to “freeze” the operation of the machine if the temperature is below useful range.

After entering the user menus (see top of page 9), Press PRG until DTD displays.

Use the arrow keys to set it to OFF (default), or 10, 20, 30, etc.



If the current temperature drops below the set temperature by that many degrees, the timer will not operate, and therefore on an automatic press, the press will not activate. The press will “unfreeze” once the temperature is within set point by the value selected or less.

For Example - DTD is set for 20. The temperature setting is for 400. As long as the current actual temperature is higher than 380, the timer (and automatic activation if the press is automatic) will operate normally. If the temperature drops to 380 or below, the timer will not start, and on automatic presses, the press will not activate. Set to OFF to disable.

Press PRG to move to the next menu item.

Keypad Beeper

The keypad beep can be silenced if needed. After entering the user menu (see top of page 13), Press PRG until BEP displays. Use the arrow keys to set it to ON or OFF.

Press PRG to move to the next menu item.

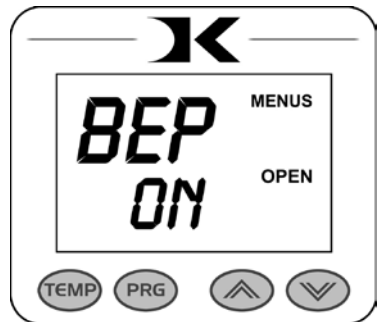

Alarms

The timer alarm can be adjusted for different beeping patterns. This can differentiate between multiple presses, and allow the operator to have a short beep or a continuously repeating beep.

After entering the user menus (see top of page 14), Press PRG until ALR displays. Use the arrow keys to set it to OFF, or 1 through 10.



Press PRG to move to the next menu item.

- denotes a short beep.
- _ denotes a longer beep.
- ~ denotes infinite loop.

| <u>Alarm #</u> | <u>Alarm Pattern</u> |
|----------------|----------------------|
| Off | No alarm |
| 01 | ••• _ |
| 02 | ••• _ ~ |
| 03 | •• _ |
| 04 | •• _ ~ |
| 05 | ••• |
| 06 | ••• ~ |
| 07 | _ ~ |
| 08 | _ |
| 09 | • |
| 10 | • (shorter) |

Finished Warning Beep

The press can sound a beep on the last 3 seconds of the timer or Prepress timer countdown. This is useful if the press is automatic and the operator needs a warning that the press is about to finish, open, or pop-up dramatically.

After entering the user menus (see top of page 14), Press PRG until FWB displays. Use the arrow keys to set it to ON or OFF.

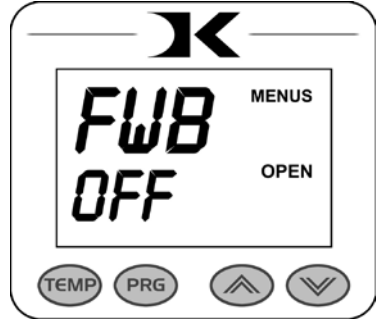

Press PRG to move to the next menu item.

Prepress Timer

The press can cycle back and forth between two distinct timer settings: the normal countdown timer, and a 2nd Prepress timer. (see page 6). This menu item turns the Prepress timer ON or OFF.

After entering the user menus (see top of page 14), Press PRG until PPR displays. Use the arrow keys to set it to ON or OFF.

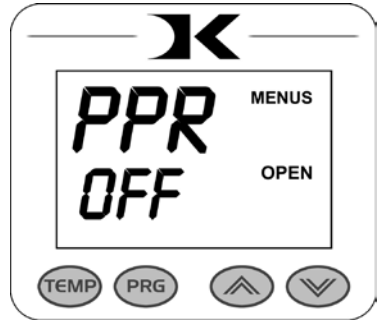

If PPR is set to OFF, pressing PRG will return to the normal operating mode.

If PPR is set to ON, pressing PRG will move to the next menu item.

Prepress Alarms

The Prepress timer alarm can be adjusted for different beeping patterns. This allows for differentiating from the normal timer, and can allow the operator to have a short beep or a continuously repeating beep.

After entering the user menus (see top of page 14), Press PRG until AL2 displays.

The PPR menu must be set to ON for this menu to be visible. Use the arrow keys to set AL2 to OFF, or 1 through 10.



Press PRG to move to the next menu item.

- denotes a short beep.
- _ denotes a longer beep.
- ~ denotes infinite loop.

| <u>Alarm #</u> | <u>Alarm Pattern</u> |
|----------------|----------------------|
| Off | No alarm |
| 01 | •••_ |
| 02 | •••_~ |
| 03 | ••_ |
| 04 | ••_~ |
| 05 | ••• |
| 06 | •••~ |
| 07 | _~ |
| 08 | - |
| 09 | • |
| 10 | • (shorter) |

Operator Lockout

An operator lockout feature is available to the owner of the press. This prevents the average user from changing any settings or adjusting anything on the controller.

Contact the factory for instructions on using this feature.



Parts / Maintenance / Misc

Interchangeable Tables

The lower table on the machine is interchangeable. Different sized optional tables can be obtained for various materials & handling requirements.

The tables simply fit right onto the table support. The sides of the angle brackets on the underside of the table will slide along the sides of the square tubing of the table support. Make sure the small bar strip falls inside the table support tubing.

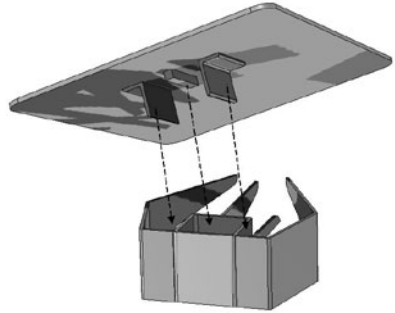

A quick release pin may be provided to lock the lower table in place, keeping it from lifting from vacuum during opening of the press.

Maintenance

The majority of the press has been designed to be as maintenance free as possible. There are only a few aspects of the machine that should be monitored to insure proper operation.

- The pressure adjustment screw is an area of wear and stress on the machine and should be checked occasionally for loss of threading. Check the threads of the pressure screw and the pressure block it screws into and replace if needed.
- The handle arm and moving linkage is another area of greatest wear and stress on the machine. Check the 8 pivot bolts and nuts that hold all the blue linkage frame pieces together. Make sure the nuts are not loosening and causing the moving frame pieces to loosen. Loss of pressure and will result. If loosening, use LOCTITE Threadlocker or equivalent on the threads of the bolts to make sure the nuts to not unwind prematurely. If the holes the pivot bolts pass through are oveled or worn, replace that part of the frame by contacting the factory.
- The silicone pad on the lower table can degrade after much use and over an extended period of time. This pad is replaceable.

Replacement Parts

Here is a list of current replaceable parts on the DK20 and DK16 as of the writing of this manual:

| | |
|---------------------|--|
| DKA-20BASE | DK20 CLAM LOWER BASE FRAME |
| DKA-16BASE | DK16 CLAM LOWER BASE FRAME |
| DKA-20HNDL..... | DK20 CLAM HANDLE ASSEMBLY |
| DKA-16HNDL..... | DK16 CLAM HANDLE ASSEMBLY |
| DKA-20PRS | DK20 CLAM PRESSURE ARM ASSEMBLY |
| DKA-16PRS | DK16 CLAM PRESSURE ARM ASSEMBLY |
| DKA-FRMLNK..... | DK20/16 PRESSURE SIDE LINK (2 req) |
| DK20-PAS | DK16/20 PRESSURE ADJUSTMENT KNOB |
| DKA-PRSBSH..... | DK20/16 PRESSURE LEVELING ASBLY |
| MEN-DKLRGPB..... | DK LARGE PRESSURE BLOCK 2 X 2 |
| MEN-GGS21120S | GAS SPRING 120# GGS21 (DK20) |
| MEN-GGS4380S | GAS SPRING 80# GGS43 (DK16) |
| FAS-AB38½..... | 3/8 X ½ SOCKET HD SHOULDER SCREW |
| FAS-GB38U..... | 3/8 ID X 3/4 OD 1/32 BRONZE WASHER |
| FAS-EL51618 | 5/16-18 ZINC TWO-WAY LOCK NUT |
| MEN-5162½QP | 5/16" X 2½" QUICK RELEASE PIN |
| DKA-CTRLC..... | DIGITAL KNIGHT PROCESSOR BOARD |
| DKA-CTRLP | DIGITAL KNIGHT POWER BOARD |
| ELN-KM0227A1 | DIGITAL KNIGHT MEMBRANE KEYPAD |
| RPK-DKPWR..... | DK POWER INLET/SWITCH/CORD KIT |
| RPK-DKPSKIT..... | DK PRESSURE SENSOR KIT |
| DK20-HBA120 | DK20 16X20 HEATER BLOCK ASBLY 120V |
| DK16-HBA120..... | DK16 14X16 HEATER BLOCK ASBLY 120V |
| DKA-1620TBL..... | DK 16 X 20 DROP-ON TABLE (w/ silicone pad) |
| DKA-1416TBL..... | DK 14 X 16 DROP-ON TABLE (w/ silicone pad) |
| SRM-381620..... | 3/8 X 16 X 20 SILICON SPONGE |
| SRM-381416..... | 3/8 X 14 X 16 SILICON SPONGE |
| SHN-DK20HBC | DK20 16X20 HEATER BLOCK COVER |
| SHN-DC16HBC | DC16 14X16 HEATER BLOCK COVER |
| ELN-K35TC | K-35" THERMOCOUPLE |
| ELN-MSTB2.5..... | OST 5MM TRMNL THERMOCOUPLE PLUG |

Digital Knight Heat Press Wiring Diagram

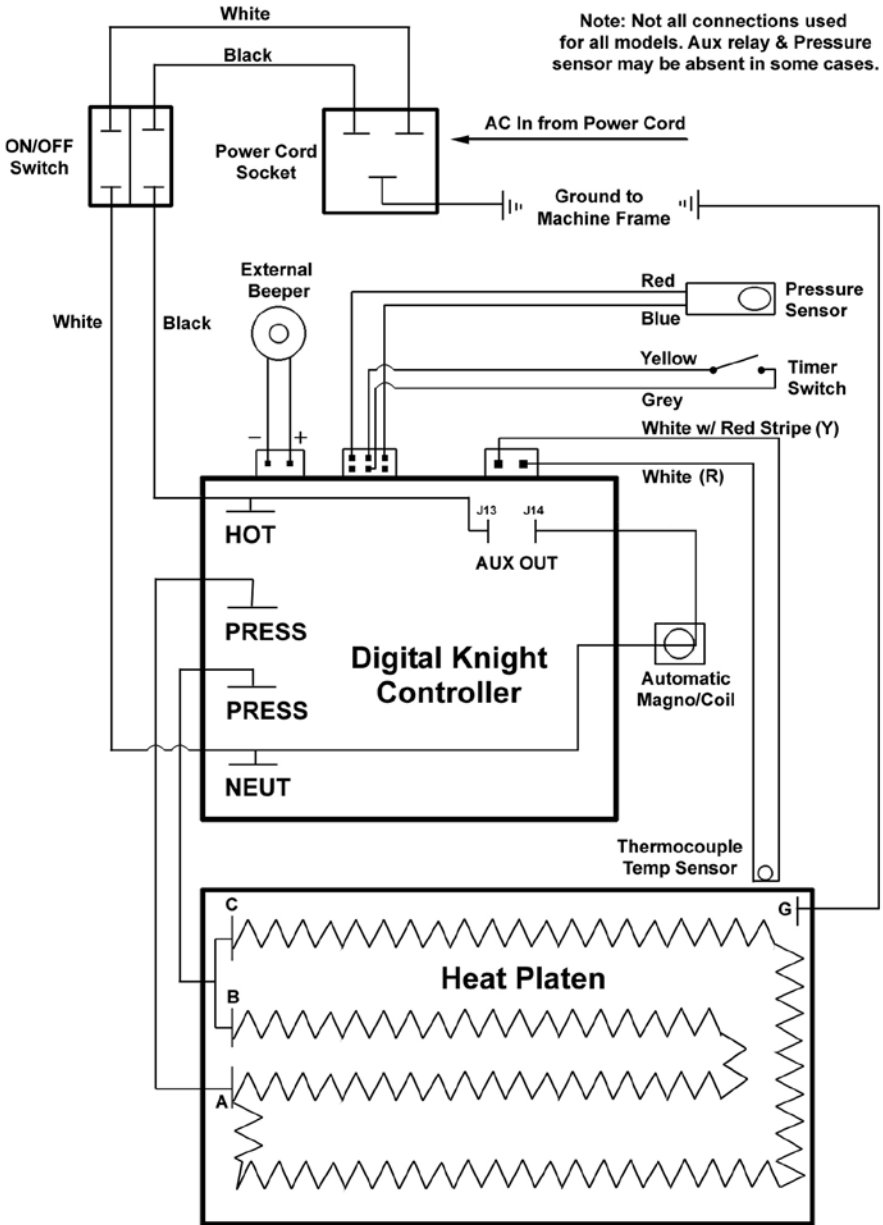

Note: Not all connections used for all models. Aux relay & Pressure sensor may be absent in some cases.

110V wiring shown
 One power lead to A
 Other power lead to B & C joined

For 220V, connect power leads to B & C, leave A empty

Troubleshooting

The following information attempts to address the most probable mechanical and user issues with the press. Most issues with heat transfer presses are application related. That is, they have to do with the results of a particular transfer application.

For technical support on problems having to do with the final results of a particular transfer paper or media, please contact the supplier of that transfer media. Generally, the machinery manufacturer is unable to support the myriad of different transfer papers, inks and impritable items on the market from other resellers.

Q. The timer does not start when I close the heat platen, or the timer does not reset when I open the press up.

A. There are several probable causes for this. The timer is activated by a micro-tilt-sensor stuck to the pressure arm. First: When the head of the machine is opened, the tilt sensor needs to be tilted slightly upward to signal the controller to stop/reset. When the head of the machine is closed, the timer sensor needs to be tilted downward (towards the floor) to signal the controller to start counting. Second: Check the wire connection from the tilt sensor into the control panel. The timer & pressure signals go to a small black 6-pin connector on the top of the circuit board in the control box. Check to make sure this is firmly seated and plugged into the board.

Q. The control displays **Err** when it first comes on, and I can not set the temperature or use the press.

A. The **Err** message will display if the heating signal from the platen has been cut off, interrupted, or the heating sensor has failed. First check the Lime Green temperature connector that plugs into the digital control. At the top of the controller, there is a green connector that plugs in with 2 small wires. This is the temperature sensor wire. Check to make sure is it properly seated. If after unplugging and plugging the lime green connector the Err message still appears. unplug the green connector and remove the 2 tiny wires from the lime green plug. Cut them back 1/4" and strip them so they have new connections. Reconnect them to the lime green plug so they are screwed in tightly and can not pull out. Plug the green plug back in and turn the press on.

Troubleshooting (cont.)

Q. I press the keys on the keypad, and there is no sound or response from the controller.

A. Check the connection of the keypad to the controller. This is inside the top panel. Unplug the power cord. Remove the two screws in between the clamp/linkage that hold down the top panel, and carefully lift the panel up and look inside at the digital controller. The keypad connector passes in through the top panel. It should wind around the first circuit board and be seated fully into the connector. Check the black keypad connector that plugs into the circuit board to see if it has pulled apart. Also check the area where the keypad connects to the front membrane to see if the leads have been damaged. The membrane keypad may need to be replaced.

Q. The gas springs are not lifting the head as easily as when the press was new, or the gas springs have lost their pressure.

A. After a large volume of use, and over an extended period of time of many, many pressing cycles, the gas springs will slowly lose their original force. These hydraulic lifter springs are extremely easy to replace, and are a surprisingly similar or even lower cost than conventional mechanical springs. Contact the factory for replacement gas springs if it is not able to keep the platen open. The gas springs must have the silver rod Face Down, and the black tube Face Up.

Q. The press has shut off, and will not come back on after checking the power cord.

A. Test for power coming from the back side of the power cord inlet socket. Test for power coming from the back side of the on/off switch. Test for power coming to the end of the black & white wires that come from the on/off switch into the control board. This will narrow down which power handling component needs replacement. RPK-DKPWR is a common replacement kit that includes all these components.

Q. I pressed a transfer upside down. The inks and transfer material have burned onto the heat platen.

A. Cool the press down. Using a nonabrasive detergent or cleaner, thoroughly scrub the heat platen surface. Do not use an abrasive scrubber, or a pad that will scratch the Teflon coating of the platen. If you are still unable to remove the transfer material, obtain teflon heater block cleaner from the factory.

Limited Warranty

Geo Knight & Co warrants that the press is free from defects in both material and workmanship One Year from the date of invoice to the buyer. If any parts or workmanship are found to be defective in manufacture, Geo Knight & Co will repair or replace the defective parts or workmanship. In addition, Geo Knight & Co warrants that the Digital Knight heat control is free from defects in both material & workmanship and is covered under no-charge support for (3) years. Geo Knight & Co also warrants that the heating element is warranted for the lifetime of the press, provided it is owned by the original purchaser. This lifetime warranty on the heating element does not cover temperature sensor failure, damage or disconnection. This warranty covers all parts to repair the defects, except when damage results from accident, alteration, misuse or abuse, or when the machine has been improperly installed, or modified in any way. If the press becomes defective during the limited warranty period of one year for the entire press, three years for the control, or the lifetime of the heating element, Geo Knight & Co reserves the right to recall the defective press to the factory for repairs if on site component replacement is deemed not possible by Geo Knight & Co. A return authorization must be granted by Geo Knight & Co prior to its return.

If a press covered by the one year limited warranty must be returned to the factory for repairs, Geo Knight & Co shall make every effort to repair buyer's press. However, Geo Knight & Co reserves the exclusive right to determine whether to repair or replace a defective press. If Geo Knight & Co authorizes a replacement press, the warranty of the replacement press shall expire on the anniversary date of the original machine's invoice to the buyer.

There are no warranties which extend beyond the description on the face hereof. Seller disclaims any implied warranty of merchantability and/or any implied warranty of fitness for a particular purpose, and buyer agrees that the goods are sold "as is". Geo Knight & Co does not warrant that the functions of the press will meet the buyers requirements or expectations. The entire risk as to use, quality and performance of the press lies with the buyer. In no event will Geo Knight & Co be liable for any damages, including loss of profits, destruction of goods or any other special, incidental, consequential or indirect damages arising from the use of the press or accompanying materials. This limitation will apply even if Geo Knight & Co or its authorized agent has been advised of the possibility of such damage.